



600W Single Output with PFC Function

HRP-600N series



Features

- Universal AC input / Full range
- Built-in active PFC function, PF>0.94
- 250% peak power capability
- High efficiency up to 89%
- Withstand 300VAC surge input for 5 seconds
- Protections: Short circuit / Overload / Over voltage / Over temperature
- Built-in cooling fan ON-OFF control
- Built-in DC OK signal
- Built-in remote sense function
- 5 years warranty

Applications

- Industrial automation machinery
- Industrial control system
- Mechanical and electrical equipment
- Diagnostic or biological facilities
- Test or measurement systems
- Telecommunication equipment

GTIN CODE

MW Search: <https://www.meanwell.com/serviceGTIN.aspx>

Description

HRP-600N is a 600W single output type AC/DC power supply. This series operates for 85~264VAC input voltage and offers the models with the DC output mostly demanded from the industry. Each model is cooled by the built-in fan with fan ON-OFF control, working for the temperature up to 70°C. Moreover, HRP-600N provides 250% short-duration peak power for motor applications and electromechanical loads requiring much higher power during start-up.

Model Encoding

HRP - 600N - 24

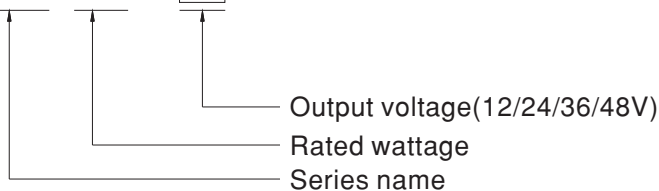

SPECIFICATION

MODEL	HRP-600N-12	HRP-600N-24	HRP-600N-36	HRP-600N-48	
OUTPUT	DC VOLTAGE	12V	24V	36V	48V
	RATED CURRENT	53A	27A	17.5A	13A
	CURRENT RANGE	0 ~ 53A	0 ~ 27A	0 ~ 17.5A	0 ~ 13A
	RATED POWER	636W	648W	630W	624W
	RIPPLE & NOISE (max.) Note.2	200mVp-p	150mVp-p	200mVp-p	240mVp-p
	VOLTAGE ADJ. RANGE	10.2 ~ 13.8V	21.6 ~ 28.8V	28.8 ~ 39.6V	40.8 ~ 55.2V
	VOLTAGE TOLERANCE Note.3	±1.0%	±1.0%	±1.0%	±1.0%
	LINE REGULATION	±0.3%	±0.2%	±0.2%	±0.2%
	LOAD REGULATION	±0.5%	±0.5%	±0.5%	±0.5%
	SETUP, RISE TIME	1800ms, 50ms/230VAC 3600ms, 50ms/115VAC at full load			
HOLD UP TIME (Typ.)	16ms/230VAC 16ms/115VAC at full load				
INPUT	VOLTAGE RANGE Note.4	85 ~ 264VAC 120 ~ 370VDC			
	FREQUENCY RANGE	47 ~ 63Hz			
	POWER FACTOR (Typ.)	PF>0.94/230VAC PF>0.98/115VAC at full load			
	EFFICIENCY (Typ.)	88%	88%	89%	89%
	AC CURRENT (Typ.)	7.6A/115VAC 3.6A/230VAC			
	INRUSH CURRENT (Typ.)	35A/115VAC 70A/230VAC			
	LEAKAGE CURRENT	<1.5mA / 240VAC			
PROTECTION	OVERLOAD	Normally works within 105 ~ 200% rated output power for more than 5 seconds and then shut down o/p voltage, re-power on to recover Constant current limiting for output power >280% rated for more than 5 seconds and then shut down o/p voltage, re-power on to recover			
	OVER VOLTAGE	14.4 ~ 16.8V	30 ~ 34.8V	41.4 ~ 48.6V	57.6 ~ 67.2V
	OVER TEMPERATURE	Shut down o/p voltage, recovers automatically after temperature goes down			
FUNCTION	DC OK SIGNAL	PSU turn on : 3.3 ~ 5.6V ; PSU turn off : 0 ~ 1V			
	FAN CONTROL (Typ.)	Load 35 ± 15% or RTH2 ≥ 50°C Fan on			
ENVIRONMENT	WORKING TEMP.	-40 ~ +70°C (Refer to "Derating Curve")			
	WORKING HUMIDITY	20 ~ 90% RH non-condensing			
	STORAGE TEMP., HUMIDITY	-40 ~ +85°C, 10 ~ 95% RH non-condensing			
	TEMP. COEFFICIENT	±0.03%/°C (0 ~ 50°C)			
	VIBRATION	10 ~ 500Hz, 5G 10min./1cycle, 60min. each along X, Y, Z axes			
OPERATING ALTITUDE Note.6	5000 meters				
SAFETY & EMC (Note 5)	SAFETY STANDARDS	UL62368-1, TUV BS EN/EN62368-1, EAC TP TC 004, AS/NZS 62368.1 approved			
	WITHSTAND VOLTAGE	I/P-O/P:3KVAC I/P-FG:2KVAC O/P-FG:0.5KVAC			
	ISOLATION RESISTANCE	I/P-O/P, I/P-FG, O/P-FG:100M Ohms / 500VDC / 25°C / 70% RH			
	EMC EMISSION	Parameter	Standard		Test Level / Note
		Conducted	BS EN/EN55032		Class B
		Radiated	BS EN/EN55032		Class B
		Harmonic current	BS EN/EN61000-3-2		Class A
	Voltage Flicker	BS EN/EN61000-3-3		-----	
	EMC IMMUNITY	BS EN/EN55035, BS EN/EN61000-6-2(BS EN/EN50082-2)			
		Parameter	Standard		Test Level / Note
		ESD	BS EN/EN61000-4-2		Level 3, 8KV air; Level 2, 4KV contact
		RF field	BS EN/EN61000-4-3		Level 3, 10V/m
		EFT/ Burst	BS EN/EN61000-4-4		Level 3, 2KV
		Surge	BS EN/EN61000-4-5		Level 4, 4KV/Line-FG; 2KV/Line-Line
Conducted		BS EN/EN61000-4-6		Level 3, 10V	
Magnetic Field		BS EN/EN61000-4-8		Level 4, 30A/m	
Voltage Dips and Interruptions	BS EN/EN61000-4-11		95% dip 0.5 periods, 30% dip 25 periods, 95% interruptions 250 periods		
OTHERS	MTBF	1380.8K hrs min. Telcordia SR-332 (Bellcore) ; 191.3K hrs min. MIL-HDBK-217F (25°C)			
	DIMENSION	218*105*61.5mm (L*W*H)			
	PACKING	1.39Kg;8pcs/12.1Kg/1.58CUFT			
NOTE	<p>1. All parameters NOT specially mentioned are measured at 230VAC input, rated load and 25°C of ambient temperature.</p> <p>2. Ripple & noise are measured at 20MHz of bandwidth by using a 12" twisted pair-wire terminated with a 0.1 μF & 47 μF parallel capacitor.</p> <p>3. Tolerance : includes set up tolerance, line regulation and load regulation.</p> <p>4. Derating may be needed under low input voltages. Please check the derating curve for more details.</p> <p>5. The power supply is considered a component which will be installed into a final equipment. All the EMC tests are been executed by mounting the unit on a 360mm*360mm metal plate with 1mm of thickness. The final equipment must be re-confirmed that it still meets EMC directives. For guidance on how to perform these EMC tests, please refer to "EMI testing of component power supplies." (as available on https://www.meanwell.com/Upload/PDF/EMI_statement_en.pdf)</p> <p>6. The ambient temperature derating of 3.5°C/1000m with fanless models and of 5°C/1000m with fan models for operating altitude higher than 2000m(6500ft).</p> <p>※ Product Liability Disclaimer : For detailed information, please refer to https://www.meanwell.com/serviceDisclaimer.aspx</p>				

Block Diagram

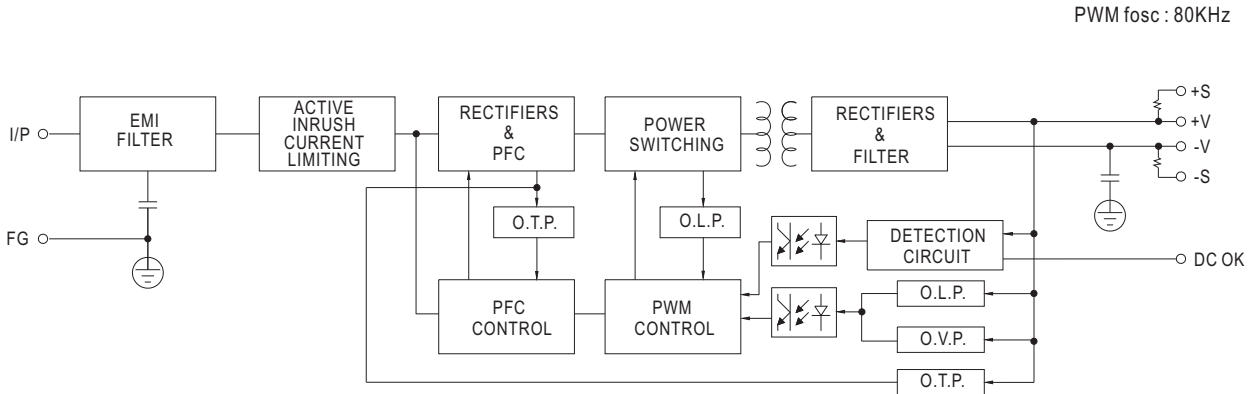

Derating Curve

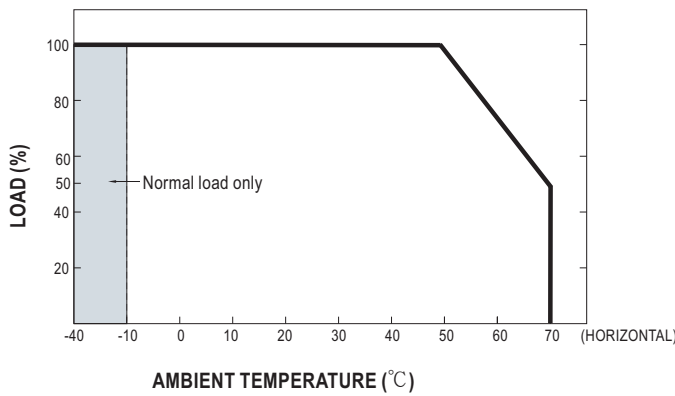

Output Derating VS Input Voltage

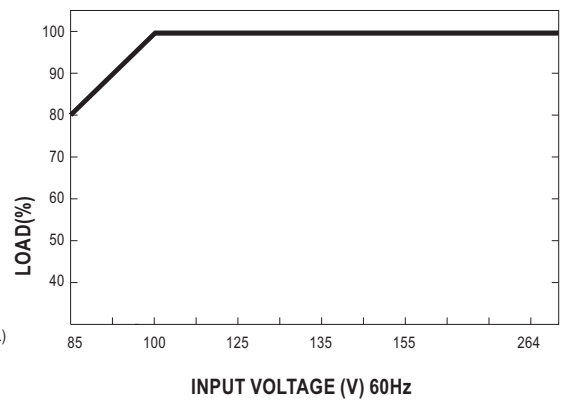

Function Manual

1. Remote Sense

The remote sensing compensates voltage drop on the load wiring up to 0.5V.

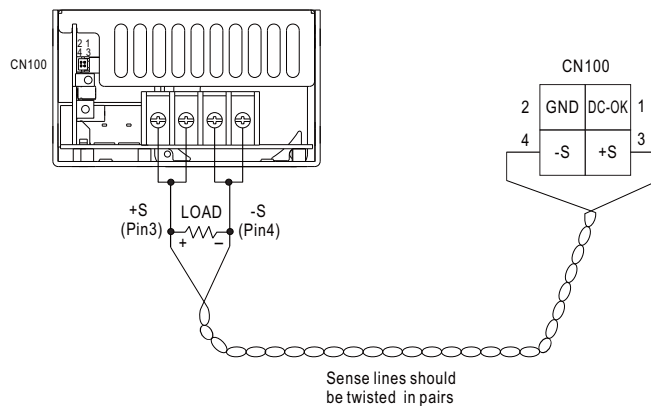

Fig 1.1

2. DC-OK Signal

DC-OK signal is a TTL level signal. High when PSU turns on.

Between DC-OK(pin1) and GND(pin2)	Output Status
3.3 ~ 5.6V	ON
0 ~ 1V	OFF

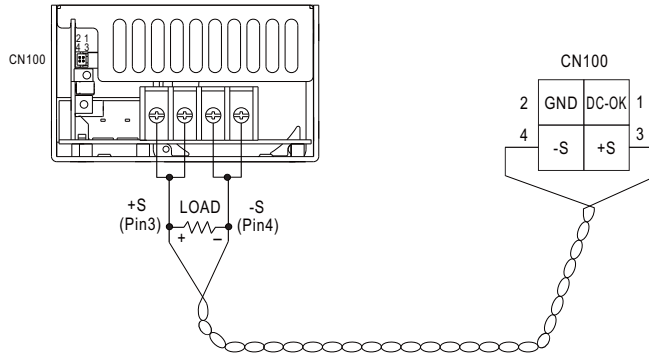

Fig 2.1

Sense lines should be twisted in pairs

3. Peak Power

$$P_{av} = \frac{P_{pk} \times t + P_{npk} \times (T-t)}{T} \leq P_{rated}$$

$$\text{Duty} \frac{t}{T} \times 100\% \leq 35\%$$

$$t \leq 5 \text{ sec}$$

P_{av} : Average output power (W)

P_{pk} : Peak output power (W)

P_{npk} : Non-peak output power (W)

P_{rated} : Rated output power (W)

t : Peak power width (sec)

T : Period (sec)

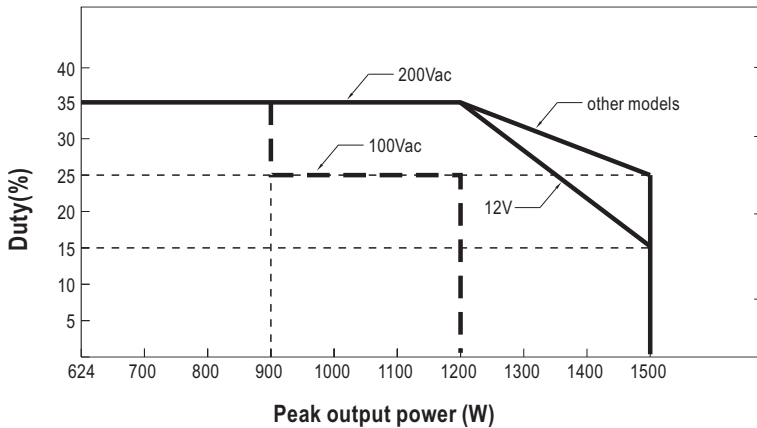
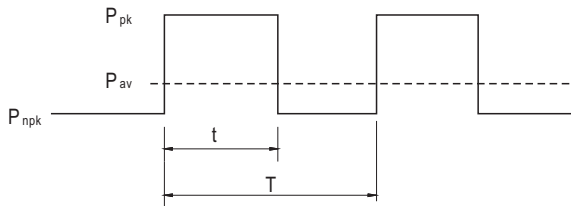

For example (12V model) :

$V_{in} = 100V$ $\text{Duty}_{max} = 25\%$

$P_{av} = P_{rated} = 636W$

$P_{pk} = 1200W$

$t \leq 5 \text{ sec}$

$T \geq 20 \text{ sec}$

$$P_{av} = \frac{P_{pk} \times t + P_{npk} \times (T-t)}{T} = \frac{1200 \times 5 + P_{npk} \times (20-5)}{20} \leq 636W$$

$P_{npk} \leq 448W$

Mechanical Specification

Case No. 977A Unit:mm

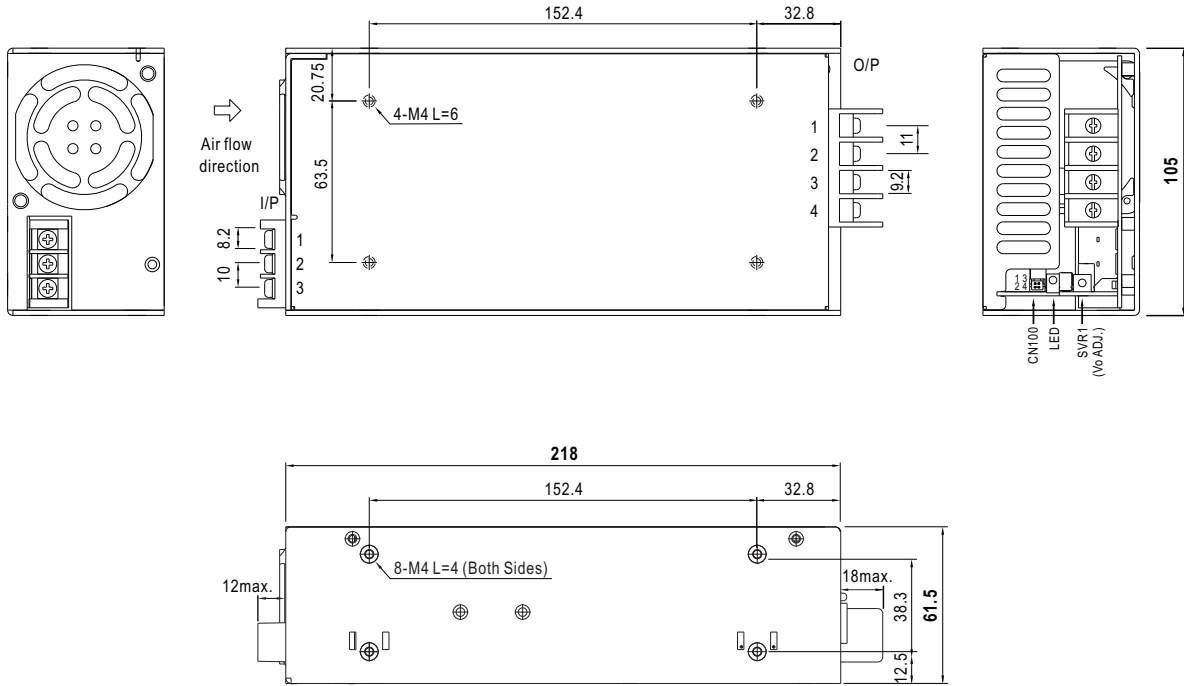

AC Input Terminal Pin No. Assignment

Pin No.	Assignment
1	AC/L
2	AC/N
3	FG \perp

DC Output Terminal Pin No. Assignment

Pin No.	Assignment
1~2	-V
3~4	+V

Connector Pin No. Assignment(CN100) : HRS DF11-4DP-2DS or equivalent

Pin No.	Assignment	Mating Housing	Terminal
1	DC-OK	HRS DF11-4DS or equivalent	HRS DF11-4SC or equivalent
2	GND		
3	+S		
4	-S		

Installation Manual

Please refer to : <http://www.meanwell.com/manual.html>