



■ Features

- 3 pole AC inlet IEC320-C14, Class I power unit
- Medical safety approved (2 x MOPP) according to ANSI/AAMI ES60601-1 and IEC/EN60601-1
- Extremely low leakage current
- No load power consumption < 0.15W
- Energy efficiency level VI and meet CoC Version 5
- -30~+70°C wide range working temperature
- Protections: Short circuit / Overload / Over voltage / Over temperature
- LED indicator for power on
- Lifetime > 80 K hours
- 3 years warranty

■ Applications

- Mobile clinical workstation
- Oral irrigator
- Portable hemodialysis machine
- Breath Machine
- Medical computer monitor

■ Description

GSM220A is a highly reliable, 220W desktop style single-output green medical adaptor series. This product is equipped with a 3-pin (with FG) standard IEC320-C14 power plug, adopting the input range from 80VAC to 264VAC. The entire series supplies different output voltages between 12VDC and 48VDC that can satisfy the demands for various kinds of medical electrical devices. The circuitry design meets the international medical standards (2*MOPP), having an ultra low leakage current (<100µA), fitting the medical devices in direct electrical contact with the patients.

With the efficiency up to 94.5% and the extremely low no-load power consumption below 0.15W, GSM220A is compliant with USA EISA 2007/DoE, Canada NRCAN, Australia and New Zealand MEPS, EU ErP, and meet Code of Conduct (CoC) Version 5. The supreme feature allows the adaptor to save the energy when it is either under the operating mode or the standby mode. The entire series utilizes the 94V-0 flame retardant plastic case. GSM220A is approved with the international medical safety certificates.

■ Model Encoding

GSM220A 12 - R7B

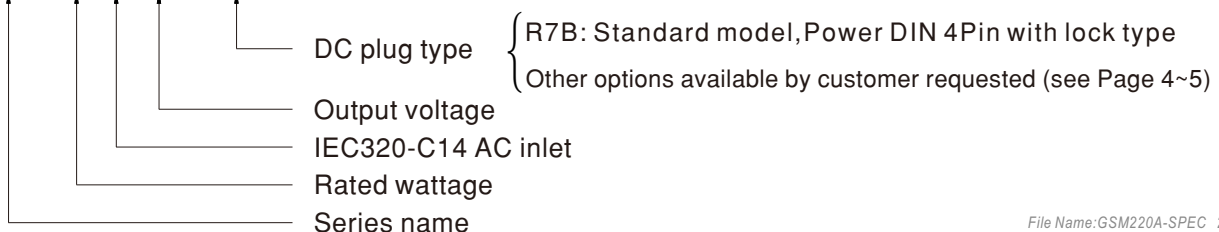

SPECIFICATION

ORDER NO.		GSM220A12-R7B	GSM220A15-R7B	GSM220A20-R7B	GSM220A24-R7B	GSM220A48-R7B	
OUTPUT	SAFETY MODEL NO.	GSM220A12	GSM220A15	GSM220A20	GSM220A24	GSM220A48	
	DC VOLTAGE Note.2	12V	15V	20V	24V	48V	
	RATED CURRENT	15A	13.4A	11A	9.2A	4.6A	
	CURRENT RANGE	0 ~ 15A	0 ~ 13.4A	0 ~ 11A	0 ~ 9.2A	0 ~ 4.6A	
	RATED POWER (max.)	180W	201W	220W	221W	221W	
	RIPPLE & NOISE (max.) Note.3	80mVp-p	80mVp-p	120mVp-p	120mVp-p	150mVp-p	
	VOLTAGE TOLERANCE Note.4	±5.0%	±5.0%	±4.0%	±3.0%	±2.0%	
	LINE REGULATION Note.5	±1.0%	±1.0%	±1.0%	±1.0%	±1.0%	
	LOAD REGULATION	±5.0%	±5.0%	±4.0%	±3.0%	±2.0%	
	SETUP, RISE TIME Note.6	2000ms, 50ms / 230VAC 2000ms, 50ms / 115VAC at full load					
HOLD UP TIME (Typ.)	20ms / 230VAC 20ms / 115VAC at full load						
INPUT	VOLTAGE RANGE Note.7	80 ~ 264VAC					
	FREQUENCY RANGE	47 ~ 63Hz					
	POWER FACTOR (Typ.)	PF>0.91 / 230VAC PF>0.98 / 115VAC at full load					
	EFFICIENCY (Typ.)	90%	90%	92%	93.5%	94.5%	
	AC CURRENT (Typ.)	4A / 115VAC 2A / 230VAC					
	INRUSH CURRENT (max.)	Cold start 55 A / 115AVC 110A / 230VAC					
LEAKAGE CURRENT(max.)	Earth leakage current < 100 µA/264VAC , Touch current <100 µA/264VAC						
PROTECTION	OVERLOAD	105 ~ 135% rated output power Protection type : Hiccup mode, recovers automatically after fault condition is removed					
	OVER VOLTAGE	105 ~ 135% rated output voltage Protection type : Shut down o/p voltage, re-power on to recover					
	OVER TEMPERATURE	Shut down o/p voltage, recovers automatically after temperature goes down					
ENVIRONMENT	WORKING TEMP.	-30 ~ +70°C (Refer to "Derating Curve")					
	WORKING HUMIDITY	20% ~ 90% RH non-condensing					
	STORAGE TEMP., HUMIDITY	-40 ~ +85°C, 10 ~ 95% RH non-condensing					
	TEMP. COEFFICIENT	±0.03% / °C (0~40°C)					
	VIBRATION	10 ~ 500Hz, 2G 10min./1cycle, period for 60min. each along X, Y, Z axes					
	OPERATING ALTITUDE Note.8	3000 meters					
SAFETY & EMC (Note. 10)	SAFETY STANDARDS	IEC60601-1, TUV EN60601-1, ANSI/AAMI ES60601-1(3.1 version), CAN/CSA-C22.2 No. 60601-1:14 - Edition 3 approved					
	ISOLATION LEVEL	Primary-Secondary: 2xMOPP, Primary-Earth: 1xMOPP					
	WITHSTAND VOLTAGE Note.9	I/P-O/P:4KVAC I/P-FG:2KVAC O/P-FG:0.5KVAC					
	ISOLATION RESISTANCE	I/P-O/P:100M Ohms / 500VDC / 25°C / 70% RH					
	EMC EMISSION	Parameter	Standard			Test Level / Note	
		Conducted emission	EN55011 (CISPR11)			Class B	
		Radiated emission	EN55011 (CISPR11)			Class B	
		Harmonic current	EN61000-3-2			Class A	
		Voltage flicker	EN61000-3-3			-----	
	EMC IMMUNITY	EN55024 , EN60601-1-2, EN61204-3					
		Parameter	Standard			Test Level / Note	
		ESD	EN61000-4-2			Level 4, 15KV air ; Level 4, 8KV contact	
		RF field susceptibility	EN61000-4-3			Level 3, 10V/m(80MHz~2.7GHz) Table 9, 9~28V/m(385MHz~5.78GHz)	
		EFT bursts	EN61000-4-4			Level 3, 2KV	
Surge susceptibility		EN61000-4-5			Level 3, 1KV/Line-Line , 2KV/Line-FG		
Conducted susceptibility		EN61000-4-6			Level 3, 10V		
Magnetic field immunity		EN61000-4-8			Level 4, 30A/m		
Voltage dip, interruption	EN61000-4-11			100% dip 1 periods, 30% dip 25 periods, 100% interruptions 250 periods			
OTHERS	MTBF	210.79K hrs min. MIL-HDBK-217F(25°C)					
	DIMENSION	210*85*46mm (L*W*H)					
	PACKING	1.1Kg; 12pcs/14.2Kg/0.73CUFT					
CONNECTOR	PLUG	See page 4-5 ; Other type available by customer requested					
	CABLE	See page 4-5 ; Other type available by customer requested					
NOTE	<ol style="list-style-type: none"> All parameters are specified at 230VAC input, rated load, 25°C 70% RH ambient. DC voltage: The output voltage set at point measure by plug terminal & 50% load. Ripple & noise are measured at 20MHz by using a 12" twisted pair terminated with a 0.1µf & 47µf capacitor. Tolerance: includes set up tolerance, line regulation, load regulation. Line regulation is measured from low line to high line at rated load. Length of set up time is measured at first cold start. Turning ON/OFF the power supply may lead to increase of the set up time. Derating may be needed under low input voltages. Please check the derating curve for more details. The ambient temperature derating of 3.5°C / 1000m is needed for operating altitude greater than 2000m(6500ft). Optional for 1.5KVAC with BF rated. The power supply is considered as an independent unit, but the final equipment still need to re-confirm that the whole system complies with the EMC directives. For guidance on how to perform these EMC tests, please refer to "EMI testing of component power supplies." (as available on http://www.meanwell.com) 						

Derating Curve

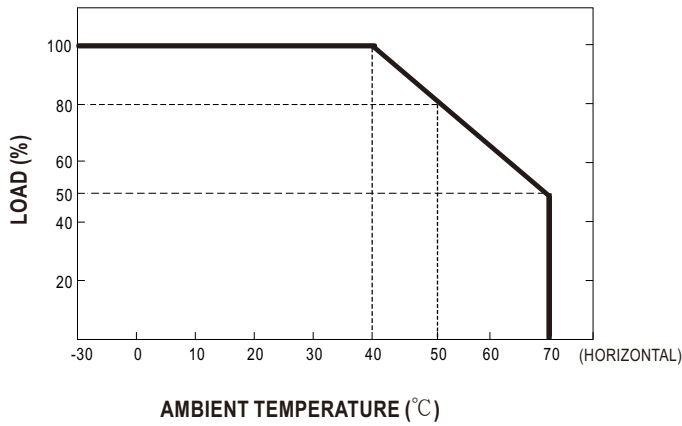

Static Characteristics

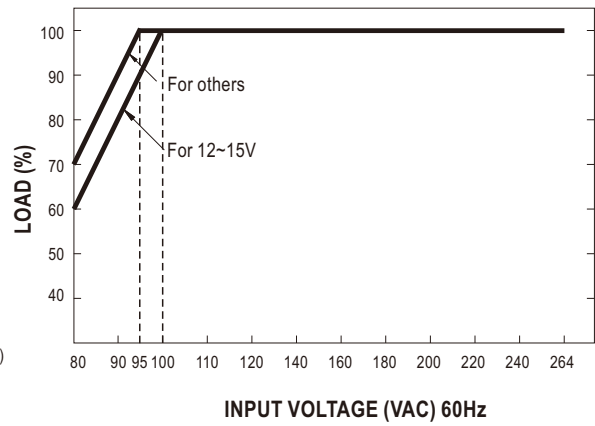

Mechanical Specification

Case No. 961A Unit:mm

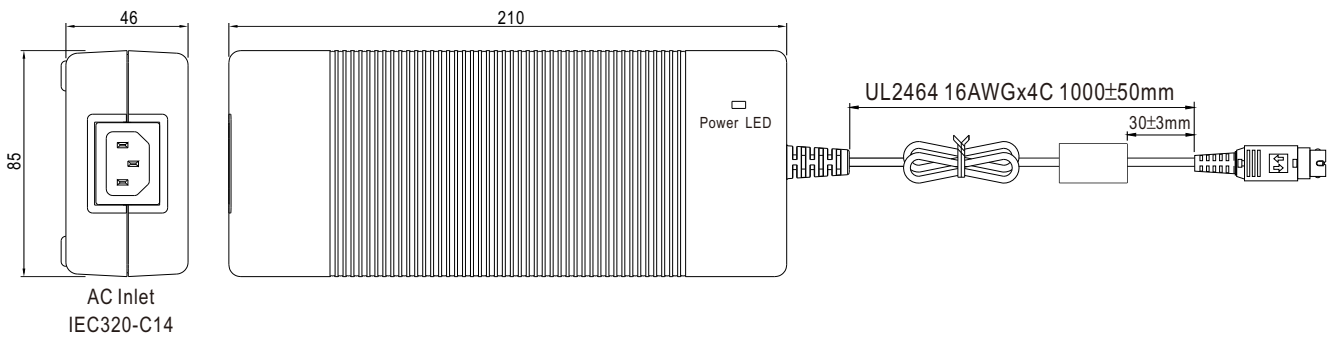









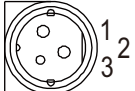
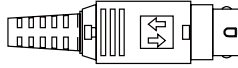

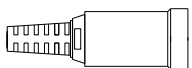

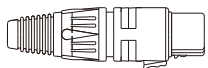

DC output plug

Standard plug: R7B

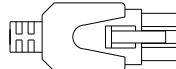
R7B		Pin Assignment											
	KYCON KPPX-4P equivalent	Outer shell connected to AC FG -V not connected to AC FG											
			<table border="1"> <thead> <tr> <th>PIN NO.</th> <th>OUTPUT</th> </tr> </thead> <tbody> <tr><td>1</td><td>+Vo</td></tr> <tr><td>2</td><td>-Vo</td></tr> <tr><td>3</td><td>-Vo</td></tr> <tr><td>4</td><td>+Vo</td></tr> </tbody> </table>	PIN NO.	OUTPUT	1	+Vo	2	-Vo	3	-Vo	4	+Vo
PIN NO.	OUTPUT												
1	+Vo												
2	-Vo												
3	-Vo												
4	+Vo												

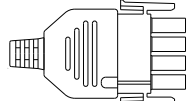
© Optional DC plug:

Min. DIN 3 Pin with Lock (male)	Type No.	Pin Assignment	
		PIN No.	Output
   <p>KYCON KPPX-3P equivalent</p>	R6B	1	+Vo
		2	-Vo
		3	+Vo
Min. DIN 4 Pin with Lock (female)	Type No.	Pin Assignment	
		PIN No.	Output
   <p>KYCON KPJX-CM-4S equivalent</p>	R7BF	1	+Vo
		2	-Vo
		3	-Vo
		4	+Vo
DIN 5 Pin (male)	Type No.	Pin Assignment	
		PIN No.	Output
  	R1B	1	-Vo
		2	-Vo
		3	+Vo
		4	-Vo
		5	+Vo
NEUTRIK XLR NC4FX equivalent	Type No.	Pin Assignment	
		PIN No.	Output
  	MIC4	1	+Vo
		2	+Vo
		3	-Vo
		4	-Vo
MOLEX 39-01-2060 (4.2mm) equivalent	Type No.	Pin Assignment	
		PIN No.	Output
   <p>FG not connected to output connector</p>	C6P	1	+Vo
		2	+Vo
		3	+Vo
		4	-Vo
		5	-Vo
		6	-Vo
AMP 1-480702-0 (6.35mm) equivalent	Type No.	Pin Assignment	
		PIN No.	Output
   <p>FG not connected to output connector</p>	C4P	1	+Vo
		2	+Vo
		3	-Vo
		4	-Vo

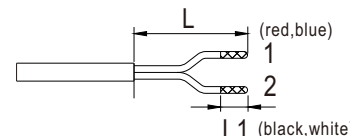
Stripped and tinned leads	Type No.	Pin Assignment	
		PIN No.	Output
  <p>Length of Land L1 by request (MW's standard length, L: <u>25</u> mm, L1: <u>5</u> mm)</p>	by customer	1	+Vo
		2	-Vo

■ **Installation Manual**

Please refer to : <http://www.meanwell.com/manual.html>