



■ Features

- Universal AC input / Full range
- Class II power unit, no FG
- Built-in active PFC function
- High efficiency up to 94%
- No load power consumption <0.15W
- Energy efficiency Level VI
- Comply with EU Erp and CoC Version 5
- Fully isolated plastic case with IP67
- Fanless design, cooling by free air convection
- Protections: Short circuit / Over current / Over voltage / Over temperature
- UL LISTED, suitable for dry and damp locations
- 5 years warranty
- [Various DC plug quick adapter accessory available \(Plug kit sold sperately, please refer to : https://www.meanwell.com/upload/pdf/DC_plug.pdf \)](https://www.meanwell.com/upload/pdf/DC_plug.pdf)

■ Applications

- Industrial field PC adaptor
- POS or KIOSK system
- Portable Battery charger
- Electric Lawn mower charger
- General electronic products in dusty or humid environment
- Household Device

■ Description

OWA-200U is one 200W single-output external power supply series. Pairing the North American type of AC plug and the prevailing DC connectors, OWA-200U, working like an adaptor, simplifies the connection with any electric device which needs waterproof function. The entire series is certified with the “UL LISTED” for dry and damp locations.

As a class II (no FG) design, the enclosure of OWA-200U is a 94V-0 flame retardant plastic case. The interior is fully potted with silicone that enhances the heat dissipation. With the working efficiency up to 94%, OWA-200U is cooled by free air convection; the working temperature ranges from -40°C to +70°C.

■ Model Encoding

OWA - 200U - 12

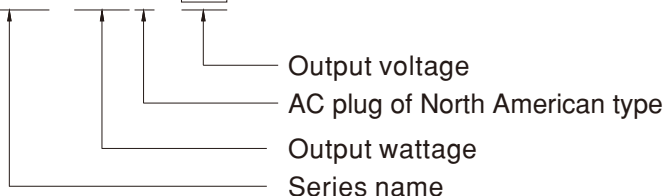



SPECIFICATION

MODEL		OWA-200U-12	OWA-200U-20	OWA-200U-24	OWA-200U-36	OWA-200U-42	OWA-200U-48	OWA-200U-54	
OUTPUT	DC VOLTAGE	12V	20V	24V	36V	42V	48V	54V	
	RATED CURRENT	15A	10A	8.3A	5.55A	4.75A	4.17A	3.71A	
	RATED POWER	180W	200W	199W	199W	199W	200W	200W	
	RIPPLE & NOISE (max.) Note.2	150mVp-p	150mVp-p	150mVp-p	200mVp-p	250mVp-p	250mVp-p	350mVp-p	
	VOLTAGE TOLERANCE Note.3	±5.0%	±4.0%	±4.0%	±3.0%	±3.0%	±3.0%	±3.0%	
	LINE REGULATION	±0.5%	±0.5%	±0.5%	±0.5%	±0.5%	±0.5%	±0.5%	
	LOAD REGULATION	±5.0%	±4.0%	±4.0%	±3.0%	±3.0%	±3.0%	±3.0%	
	SETUP, RISE TIME Note.4	500ms, 80ms 230VAC / 115VAC							
	HOLD UP TIME (Typ.)	10ms at full load 230VAC / 115VAC							
INPUT	VOLTAGE RANGE	100 ~ 264VAC 142 ~ 370VDC							
	FREQUENCY RANGE	47 ~ 63Hz							
	POWER FACTOR (Typ.)	PF>0.97/115VAC, PF>0.96/230VAC at full load							
	EFFICIENCY (Typ.)	115VAC	88.5%	90%	90.5%	91.5%	91.5%	91.5%	91.5%
		230VAC	91%	92.5%	93%	94%	94%	94%	94%
	AC CURRENT (Typ.)	2.2A / 115VAC 1.1A / 230VAC							
	INRUSH CURRENT (Typ.)	COLD START 90A(twidth=300µs measured at 50% Ipeak) at 115VAC COLD START 180A(twidth=450µs measured at 50% Ipeak) at 230VAC							
	LEAKAGE CURRENT	<0.125mA / 120VAC <0.25mA / 240VAC							
NO LOAD CONSUMPTION	<0.15W								
PROTECTION	OVER CURRENT	105% ~ 150% Protection type : Hiccup mode, recovers automatically after fault condition is removed							
	SHORT CIRCUIT	Hiccup mode, recovers automatically after fault condition is removed							
	OVER VOLTAGE	13 ~ 18V	22 ~ 27V	27 ~ 34V	41 ~ 49V	46 ~ 57V	52 ~ 65V	59 ~ 70V	
	OVER TEMPERATURE	Shut down o/p voltage, re-power on to recover							
ENVIRONMENT	WORKING TEMP.	-40 ~ +70°C (Refer to "Derating Curve")							
	WORKING HUMIDITY	20 ~ 95% RH non-condensing							
	STORAGE TEMP., HUMIDITY	-40 ~ +80°C, 10 ~ 95% RH							
	TEMP. COEFFICIENT	±0.03%/°C (0 ~ 50°C)							
	VIBRATION	10 ~ 500Hz, 5G 12min./1cycle, period for 72min. each along X, Y, Z axes							
SAFETY & EMC	SAFETY STANDARDS	UL62368-1; IP67(for power body) approved; Design refer with UL1012							
	WITHSTAND VOLTAGE	I/P-O/P:4.2KVAC							
	ISOLATION RESISTANCE	I/P-O/P:100M Ohms / 500VDC / 25°C / 70% RH							
OTHERS	EMC EMISSION	Compliance to FCC Part15							
	MTBF	851.3 K hrs min. 268.5 MIL-HDBK-217F (25°C)							
	DIMENSION	195*68*39.5mm							
NOTE	PACKING	1.32Kg; 9 pcs/ 11.74 Kg/ 0.79 CUFT							
	<p>1. All parameters NOT specially mentioned are measured at 230VAC input, rated load and 25°C of ambient temperature.</p> <p>2. Ripple & noise are measured at 20MHz of bandwidth by using a 12" twisted pair-wire terminated with a 0.1uf & 47uf parallel capacitor.</p> <p>3. Tolerance : includes set up tolerance, line regulation and load regulation.</p> <p>4. Length of set up time is measured at cold first start. Turning ON/OFF the power supply may lead to increase of the set up time.</p> <p>5. For battery charging purpose had better operation with a BMS controller.</p> <p>※ Product Liability Disclaimer : For detailed information, please refer to https://www.meanwell.com/serviceDisclaimer.aspx</p>								

Block Diagram

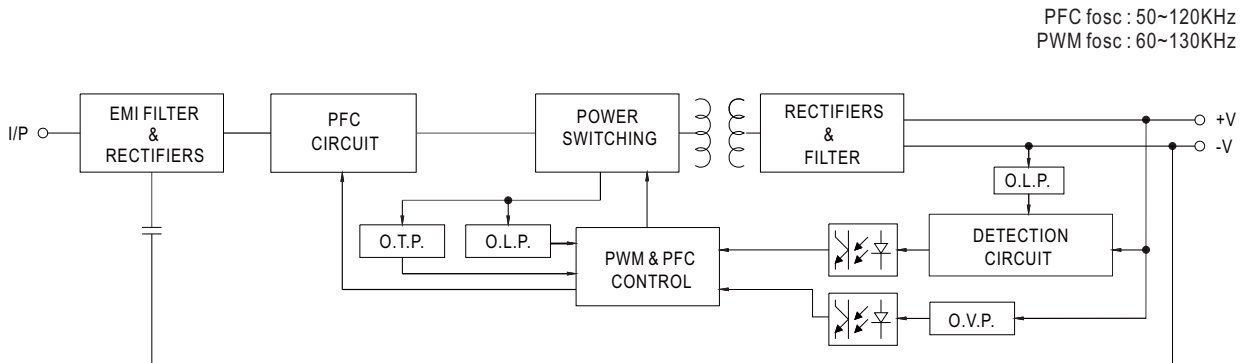

Derating Curve

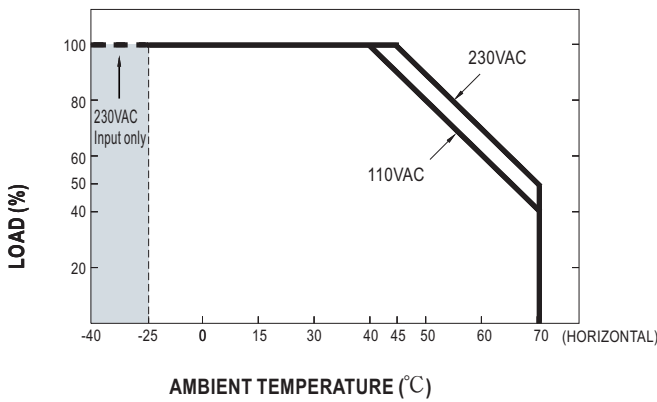

Static Characteristics

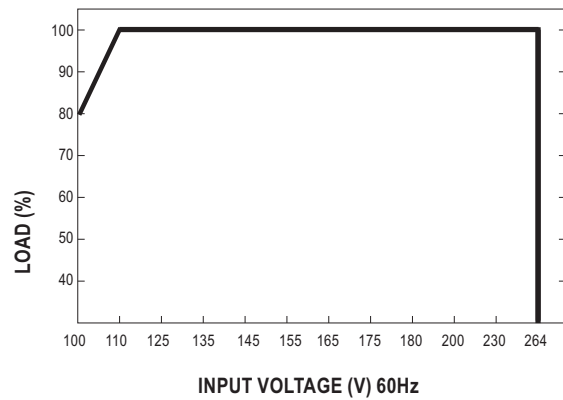

Power Factor Characteristic

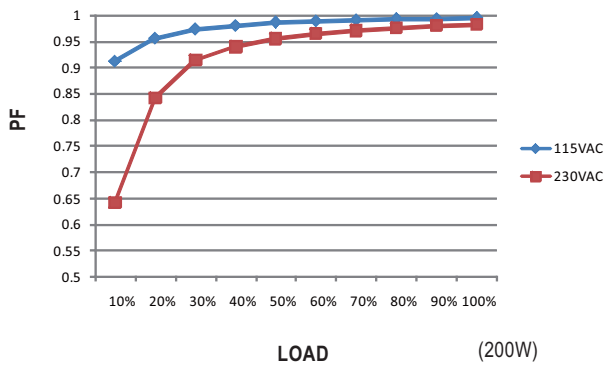

EFFICIENCY vs LOAD (48V Model)

OWA-200 series possess superior working efficiency that up to 94% can be reached in field applications.

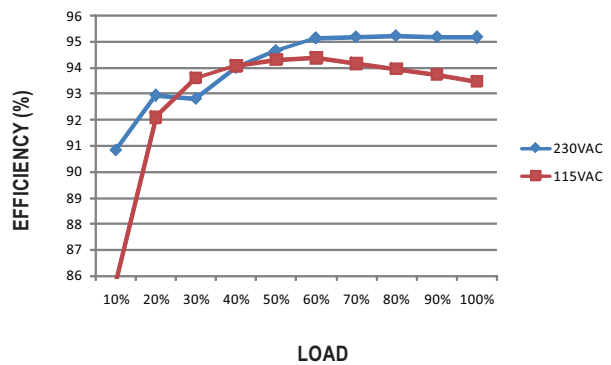

Mechanical Specification

Case No. PWM-200

Unit:mm

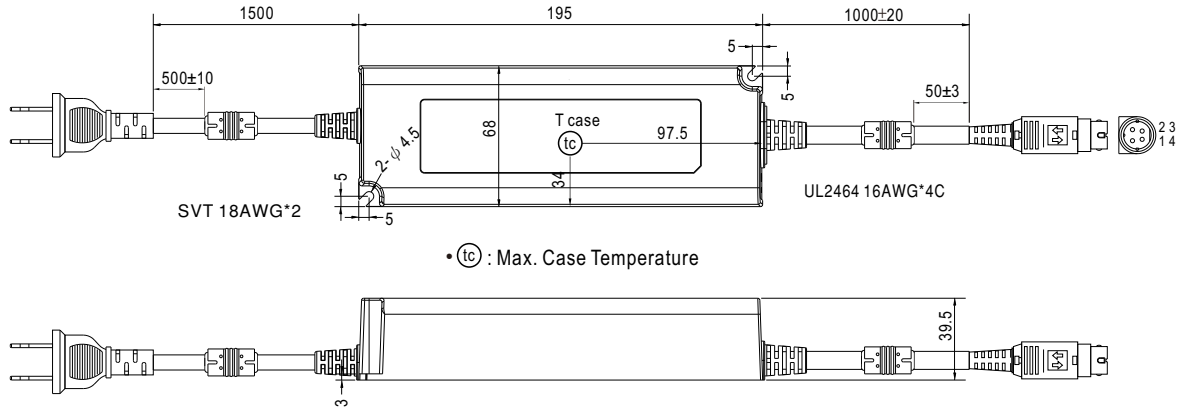

Input Plug Type

All models : NEMA 1-15p male plug

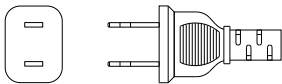



DC output plug

Standard plug:

KYCON KPPX-4P equivalent	Type No.	Pin Assignment		Available for all model (Current rating: 15A max.)
		PIN No.	Output	
	R7B	1	+Vo	
		2	-Vo	
		3	-Vo	
		4	+Vo	

Optional DC plug:

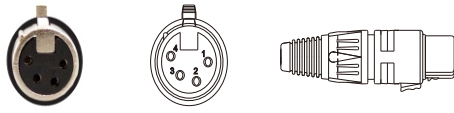
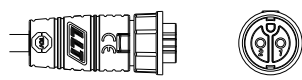
Tuning Fork Style	Type No.	A	B	C	Adaptation model
		OD	ID	L	
	P1J	5.5	2.1	11.0	Available for 36V/48V/54V (Current rating: 7.5A max.)
	P1M	5.5	2.5	11.0	
MOLEX 39-01-2060 (4.2mm) equivalent	Type No.	Pin Assignment		Available for all model (Current rating: 15A max.)	
<p>FG not connected to output connector</p>		PIN No.	Output		
	1	+Vo			
	2	+Vo			
	3	+Vo			
	4	-Vo			
	5	-Vo			
6	-Vo				

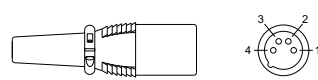
NEUTRIK XLR NC4FX equivalent	Type No.	Pin Assignment		
		PIN No.	Output	
	MIC4	1	+Vo	Available for all model (Current rating: 15A max.)
		2	+Vo	
		3	-Vo	
		4	-Vo	
LLT-M19-20002F307 equivalent	Type No.	Pin Assignment		
		PIN No.	Output	
	M19	1	+Vo	Available for all model (Current rating: 15A max.)
		2	-Vo	
DW-M15-02F equivalent	Type No.	Pin Assignment		
		PIN No.	Output	
	M15	1	+Vo	Available for 20V/24V/36V/48V/54V (Current rating: 10A max.)
		2	-Vo	
XLR4P, NEUTRIK NC4MX equivalent	Type No.	Pin Assignment		
		PIN No.	Output	
	XLR4P	1	+Vo	Available for all model (Current rating: 15A max.)
		2	+Vo	
		3	-Vo	
		4	-Vo	

※ For details, please contact MEAN WELL.

■ Recommend Mounting Direction



■ Installation Manual

Please refer to : <http://www.meanwell.com/manual.html>